

Powered by



# HRL 12280W ▶ 12V 280W

HRL 12280W is specially designed for high efficient discharge application. Its characteristics are high energy density, small footprint and high discharge efficiency. It can be used for more than 260 cycles at 100% discharge in cycle service, up to 10 years in standby service.



## Specification

Cells per unit	6
Voltage per unit	12
Capacity	280W @ 15min-rate to 1.67V per cell @25 °C(77°F)
Weight	Approx.25.8 kg(56.88 lbs)
Maximum Discharge Current	800A(5sec)
Internal Resistance	Approx. 4 mΩ
Operating Temperature Range	Discharge: -15°C~50°C ( 5°F~122°F) Charge: -15 °C~40°C( 5°F~104°F) Storage: -15°C~40°C( 5°F~104°F)
Nominal Operating Temperature Range	25°C±3°C (77°F±5°F)
Float Charging Voltage	13.5 to 13.8 VDC/unit Average at 25°C (77°F)
Recommended Maximum Charging Current Limit	28A
Equalization and Cycle Service	14.4 to 15.0 VDC/unit Average at 25°C (77°F)
Self Discharge	CSB Batteries can be stored for more than 6 months at 25°C (77°F). Please charge batteries before using. For higher temperatures the time interval will be shorter.
Terminal	I2-Thread lead alloy recessed terminal to accept M6/M8 bolt
Container Material	Polypropylene(UL 94-V0/File E50955)*Flammability resistance of (UL 94-HB/File E216959) can be available upon request.



CSB-manufactured VRLA batteries are UL-recognized components under UL924 and UL1989.

CSB is also certified by ISO 9001 and ISO 14001.

Dimensions :	Overall Height (H)	Container height (h)	Length (L)	Width (W)
Unit: mm (inch)	213.9±2.5 (8.42±0.10)	210.5±2.5 (8.29±0.10)	261.0±2.5 (10.28±0.10)	168.5±2.0 (6.64±0.08)

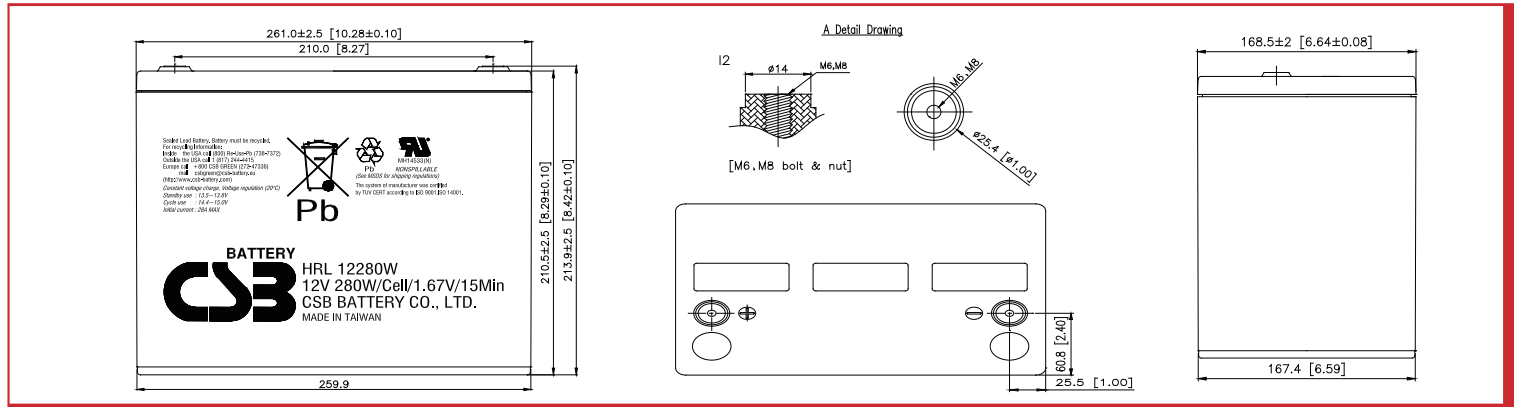

## Constant Current Discharge Characteristics Unit:A (25°C, 77°F)

F.V/Time	5MIN	10MIN	15MIN	20MIN	30MIN	40MIN	45MIN	50MIN	60MIN	90MIN
1.60V	318	216	167	137	103	82.6	76.0	70.1	59.9	44.6
1.67V	283	200	155	128	98.3	79.9	72.9	67.1	57.7	42.1
1.70V	266	192	149	124	96.3	78.1	71.2	65.4	55.6	40.6
1.75V	236	175	141	117	91.3	75.9	68.5	63.5	53.8	38.5
1.80V	207	161	131	111	85.4	70.5	63.7	58.8	50.1	36.3
1.85V	178	145	122	105	81.3	65.8	59.7	55.1	47.3	34.7

## Constant Power Discharge Characteristics Unit:W (25°C, 77°F)

F.V/Time	5MIN	10MIN	15MIN	20MIN	30MIN	40MIN	45MIN	50MIN	60MIN	90MIN
1.60V	3,354	2,304	1,788	1,476	1,110	888	822	762	648	485
1.67V	3,036	2,166	1,700	1,417	1,079	876	804	738	636	466
1.70V	2,880	2,100	1,643	1,384	1,060	864	792	726	618	454
1.75V	2,615	1,955	1,575	1,326	1,023	834	780	703	600	436
1.80V	2,329	1,800	1,493	1,274	980	802	738	678	581	422
1.85V	2,016	1,656	1,408	1,212	938	760	694	636	550	404

### Trickle (or Float) Service Life

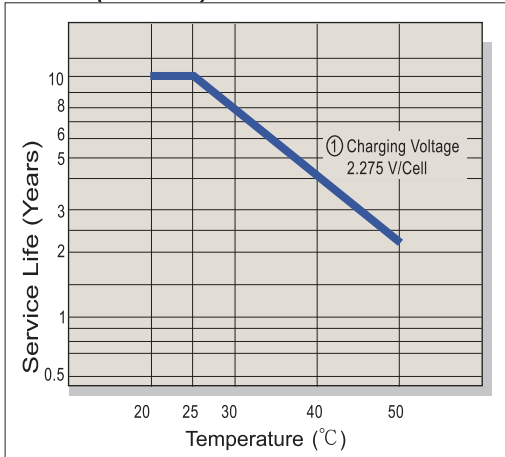

### Capacity Retention Characteristic

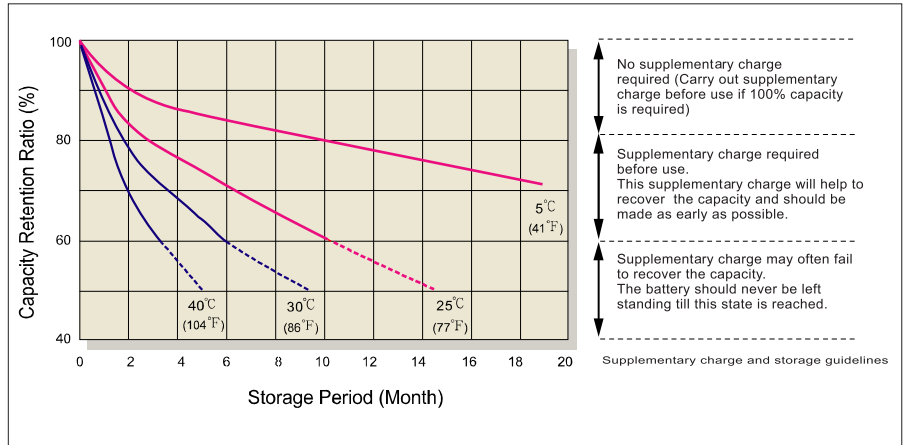

### Battery Voltage and Charge Time for Standby Use

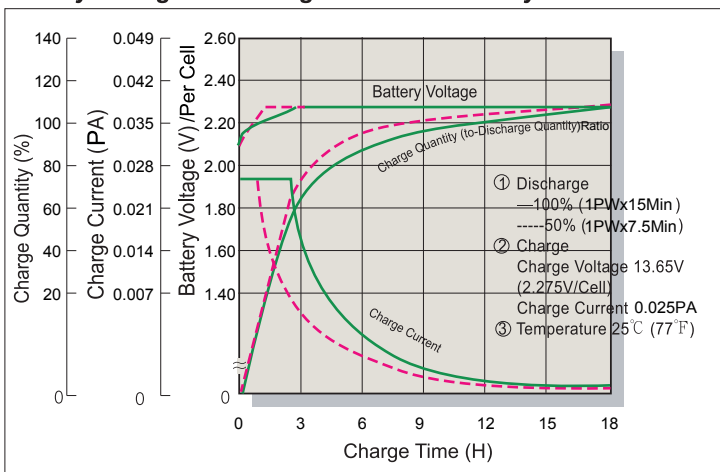

### Cycle Service Life

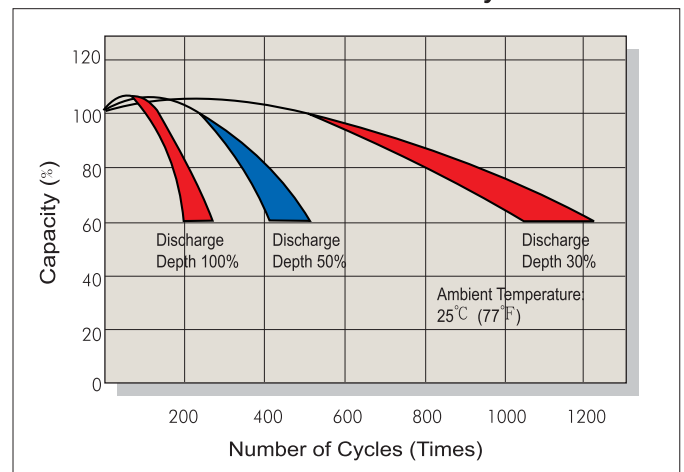

### Battery Voltage and Charge Time for Cycle Use

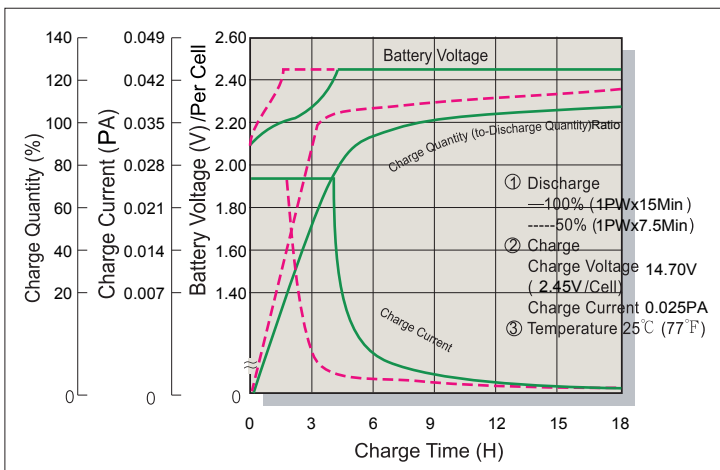

### Terminal Voltage (V) and Discharge Time

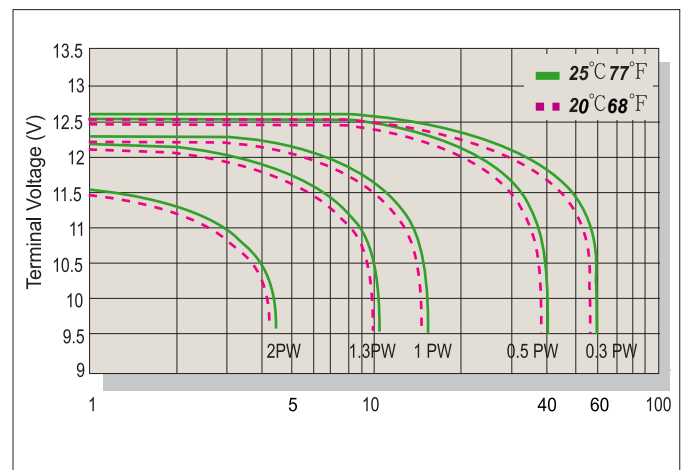

### Charging Procedures

Application	Charge Voltage(V/Cell)			Max.Charge Current
	Temperature	Set Point	Allowable Range	
Cycle Use	25°C(77°F)	2.45	2.40~2.50	0.1PA
Standby	25°C(77°F)	2.275	2.25~2.30	

### Discharge Current VS. Discharge Voltage

Final Discharge Voltage V/Cell	1.75	1.70	1.60	1.30
Discharge Power(W)	0.1P>(W)	0.1P≤(W)<0.25P	0.25P≤(W)<1.0P	(W)≥1.0P

Sales Office URL:WWW.CSB-BATTERY.COM

**GLOBAL HQ**  
**CSB BATTERY CO., LTD. (TAIWAN)**  
 Tel : +886-2-2555-5600  
 Fax : +886-2-2555-3300  
 mail : service@csb-battery.com.tw

**BEIJING OFFICE. (CHINA)**  
**CSB BATTERY TECHNOLOGIES (BEIJING) CO., LTD.**  
 Tel : +86-10-59621300/1301/1302/1303  
 Fax : +86-10-59621304  
 mail : chinasl@csb-battery.com

**AMERICA HQ**  
**CSB BATTERY TECHNOLOGIES INC. (U.S.A)**  
 Tel : +1-817-244-7777/1-(800)3-CSB-USA(272872)  
 Fax : +1-817-244-4445  
 mail : csb@csb-battery.com

**SHANGHAI OFFICE. (CHINA)**  
**CSB BATTERY LOGISTIC (SHANGHAI) CO., LTD.**  
 Tel : +86-21-5046-1622/5046-0833  
 Fax : +86-21-5064-3314  
 mail : chinasl@csb-battery.com

**EUROPE HQ**  
**CSB Battery Europe BV.**  
 Tel : +31(0)-180-418-140  
 Fax : +31(0)-180-418-327  
 mail : eurosales@csb-battery.eu

**SHENZHEN OFFICE. (CHINA)**  
**CSB BATTERY LOGISTIC (SHANGHAI) CO., LTD.**  
 Tel : +86-755-8831-6488/6396/6356  
 Fax : +86-755-8831-6548  
 mail : she@csb-battery.com.cn